

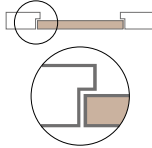

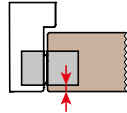

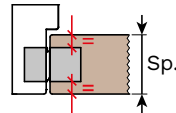

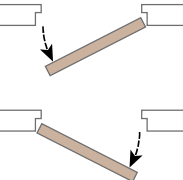
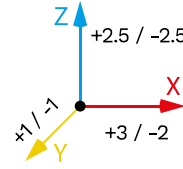

# KUBICA K6200

<b>MATERIALE</b>  Zama	<b>PORTATA</b> 45 kg (2 cerniere) 60 kg (3 cerniere) 	<b>APPLICAZIONE</b> Porta a filo-muro 	<b>MISURA K</b>  K-max 4 mm									
<b>CERNIERA CENTRATA</b>  Sp. max 31 mm	 <b>ANGOLO DI APERTURA</b> 180°	 <b>REGOLAZIONE 3D</b> Z +2.5 / -2.5 X +3 / -2 Y x1 / -1										
 Testata con chiudiporta*	<b>FINITURA</b> Full HD 	<b>MATERIALE COVER</b> Alluminio  Kit cover vite (optional)	<b>NUMERO FULCRI</b> 5 									
 Product Quality Multi-axis, concealed hinges EAD 020001-01-0405 Reg.-N°: 9000283	Rif. report reference N° R27182-20130522 	EN 1634-1  <b>30 min.</b>	EN 1670 Resistenza alla corrosione <b>240 ore</b>									
<table border="1"> <tr> <td><b>CE</b></td> <td>Krona Koblenz SpA Via Romero, 1 47853 Coriano</td> <td>18</td> </tr> <tr> <td>0757</td> <td>ETA-17/0575 DOP/DOP-N. 004/ITA/CPRI/2018-02-01</td> <td>2 7 2 1 1 4 0 7</td> </tr> <tr> <td colspan="2">HINGES DO NOT CONTAIN HARMFUL SUBSTANCES</td> <td>KUBICA K6200</td> </tr> </table>	<b>CE</b>	Krona Koblenz SpA Via Romero, 1 47853 Coriano	18	0757	ETA-17/0575 DOP/DOP-N. 004/ITA/CPRI/2018-02-01	2 7 2 1 1 4 0 7	HINGES DO NOT CONTAIN HARMFUL SUBSTANCES		KUBICA K6200	<b>MADE IN ITALY</b> 		
<b>CE</b>	Krona Koblenz SpA Via Romero, 1 47853 Coriano	18										
0757	ETA-17/0575 DOP/DOP-N. 004/ITA/CPRI/2018-02-01	2 7 2 1 1 4 0 7										
HINGES DO NOT CONTAIN HARMFUL SUBSTANCES		KUBICA K6200										

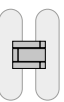
\*Testata con i modelli di chiudiporta più diffusi sul mercato.



Info prodotto:



Serie Classic

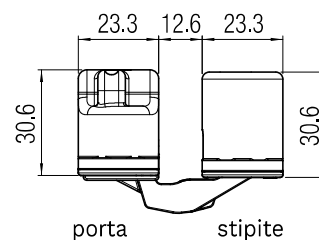
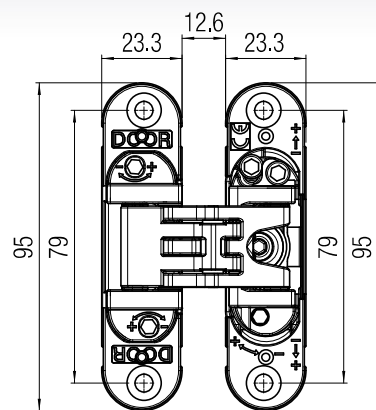

## Finiture

Colore	Codice art.
	Cromo lucido <b>K 6200 CL HD</b>
	Cromo satinato <b>K 6200 CS HD</b>
	Nichel satinato <b>K 6200 NS HD</b>
	Oro lucido <b>K 6200 OR HD</b>
	Bronzo <b>K 6200 BR HD</b>
	Bianco <b>K 6200 BI HD</b>
	Nero <b>K 6200 NR HD</b>

Per finiture differenti contatta Krona Koblenz per fattibilità

**Tabella di portata** (vedi pagina 12 per la guida alla lettura)

K6200 - 45 Kg - N° 2 cerniere													
2000		*45	*45	*45	*45	*45	*45	*45	*43	*41	39	37	36
1950		*45	*45	*45	*45	*45	*45	*43	*42	40	38	37	35
1900		*45	*45	*45	*45	*44	*42	40	39	37	36	34	
1850		*45	*45	*45	*45	*43	*41	39	38	36	35	33	
1800		*45	*45	*45	*44	*42	40	38	37	35	34	32	
1750		*45	*45	*45	*43	*41	39	37	36	34	33	32	
1700		*45	*45	*44	*42	40	38	36	35	33	32	31	
1650		*45	*45	*43	*41	39	37	35	34	32	31	30	
1600		*45	*45	*42	39	37	36	34	33	31	30	29	
1550		*45	*45	40	38	36	35	33	32	30	29	28	
1500		*45	*44	39	37	35	33	32	31	29	28	27	
1450		*45	*42	38	36	34	32	31	30	28	27	26	
1730	<b>45</b>												
	900	700	800	900	950	1000	1050	1100	1150	1200	1250	1300	
	Larghezza pannello (mm)**												

\*Considerare portata 40 Kg per conformità CE

**Fresata porta/stipite**

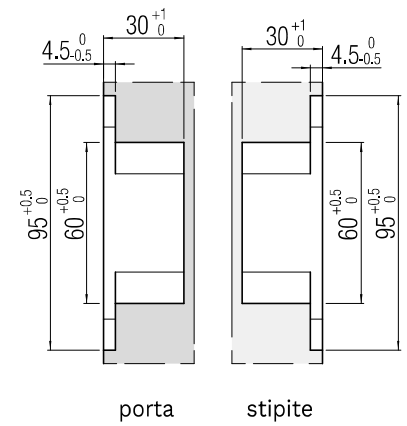

K6200 - 60 Kg - N° 3 cerniere													
2000		60	60	60	60	60	59	57	54	52	50	48	
1950		60	60	60	60	60	58	55	53	51	49	47	
1900		60	60	60	60	59	56	54	52	49	47	46	
1850		60	60	60	60	58	55	52	50	48	46	44	
1800		60	60	60	59	56	54	51	49	47	45	43	
1750		60	60	60	57	55	52	50	47	46	44	42	
1700		60	60	59	56	53	51	48	46	44	42	41	
1650		60	60	57	54	52	49	47	45	43	41	40	
1600		60	60	55	53	50	48	45	43	42	40	38	
1550		60	60	54	51	48	46	44	42	40	39	37	
1500		60	59	52	49	47	45	43	41	39	37	36	
1450		60	57	50	48	45	43	41	39	38	36	35	
1730	<b>60</b>												
	900	700	800	900	950	1000	1050	1100	1150	1200	1250	1300	
	Larghezza pannello (mm)**												

**Installazione cerniera centrata**

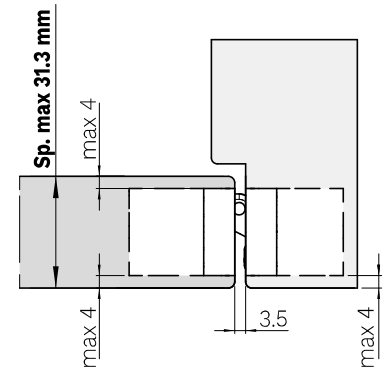

**Installazione cerniera NON centrata**

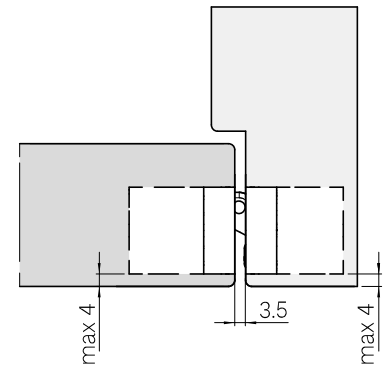

- Testata su porte: altezza 2100 mm - larghezza 900 mm - angolo di apertura 0°-90°.

\*\*Con pannello di dimensioni ed angolo max di apertura differenti dalla configurazione testata e/o con l'applicazione congiunta di altri dispositivi quali, ad esempio, chiudiporta/paracolpi/maniglione antipanico/guar-nizione a ghigliottina/ecc. fare riferimento agli "Esempi di installazione". Si ricorda che i test per queste con-figurazioni sono a cura e sotto la responsabilità del cliente. Specifichiamo che le combinazioni sono frutto di interpolazione e non di test reale, che rimane a cura e sotto la responsabilità del cliente.

**Quote applicazione standard**

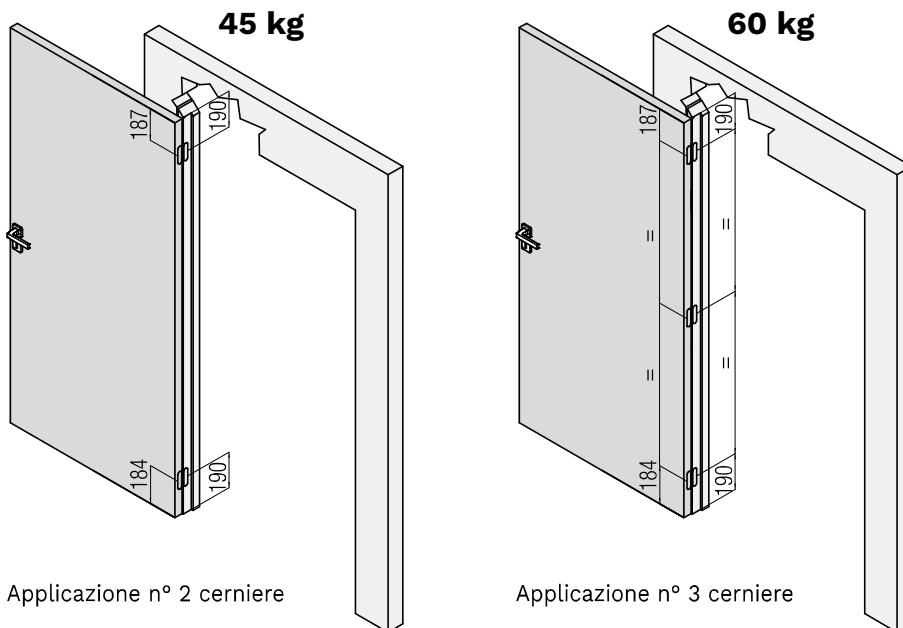

Applicazione n° 2 cerniere

Applicazione n° 3 cerniere

 Il fissaggio della cerniera è garantito utilizzando le viti di fissaggio indicate nelle istruzioni di montaggio della cerniera.